

RCA VICTOR MODELS 262 AND 263

Ten-Tube, Five-Band A. C. Superheterodyne

SERVICE NOTES

ELECTRICAL SPECIFICATIONS

Voltage Ratings.....	105-125 Volts
Frequency Ratings.....	25-60 Cycles and 50-60 Cycles
Power Consumption.....	130 Watts at 125 Volts, 50 Cycles; 130 Watts at 125 Volts, 25 Cycles
Number and Type of Radiotrons	2 RCA-6D6, 1 RCA-6A7, 2 RCA-76, 1 RCA-85, 2 RCA-42, 2 RCA-80—Total, 10
Tuning Frequency Ranges.....	{ Band X— 140 KC— 410 KC Band A— 540 KC— 1720 KC Band B— 1720 KC— 5400 KC Band C— 5400 KC—18,000 KC Band D—18,000 KC—36,000 KC
Line-up Frequencies.....	175 KC, 410 KC, 460 KC, 600 KC, 1720 KC, 5160 KC, and 18,000 KC
Maximum Undistorted Output.....	7 Watts
Maximum Output.....	14 Watts

PHYSICAL SPECIFICATIONS

	<i>Model 262</i>	<i>Model 263</i>
Height.....	42½ Inches	42⅞ Inches
Width.....	27 Inches	29 Inches
Depth.....	14½ Inches	16⅝ Inches

This ten-tube, five-band, all-wave superheterodyne radio receiver is an instrument in which most of the important modern radio developments have been incorporated. Wide tuning range, excellent sensitivity and selectivity and a large undistorted output contribute to the realization of outstanding performance in all major requirements. The extremely wide tuning range (140 KC to 36,000 KC except for a break between 410 KC and 540 KC) covers every broadcasting, police, aviation and amateur band used throughout the world.

Important new operating features include an "air-plane" type dial with band indicator, a "second" hand for vernier tuning and "band spread," a double-ratio vernier drive and the usual sensitivity and volume control.

A high degree of tonal fidelity is obtained through the use of a high gain, high output, low distortion audio amplifier and a large 10-inch electro-dynamic loudspeaker. The high and low frequency tone controls provide a method whereby the frequency characteristic may be altered for adverse operating conditions such as static, station hum, etc.

DESCRIPTION OF ELECTRICAL CIRCUIT

The general circuit arrangement consists of an R. F. stage, a combined oscillator and first detector, an I. F. stage, a combined second detector, and audio amplifier stage and AVC, a push-pull audio driver stage and a push-pull Pentode output stage. Plate and grid voltages are supplied by a heavy duty rectifier stage combined with a suitable filtering stage, of which the loudspeaker field is a part. Figure 3 shows a typical schematic circuit diagram.

The signal enters the receiver through a shielded antenna lead and is applied to the grid of the R. F.

tube through the antenna coupling transformer. The secondary of this transformer is tuned to the signal frequency by means of one unit of the gang-capacitor. The output of this stage is transformer coupled to the grid circuit of the first detector, which is also tuned to the signal frequency by a unit of the gang-capacitor.

Combined with the signal in the first detector is the local oscillator signal, which is always at a 460 KC frequency difference (higher) from the signal frequency. A separate coil system and the third unit of the gang-capacitor are used in the oscillator circuit.

In conjunction with these three tuned circuits it is well to point out that five different groups of tuned circuits are used, one group for each tuning band. A five-position selector switch is provided for selecting the band in which the desired signal is located. In addition to selecting the desired coil system, additional groups of contacts are provided for short-circuiting

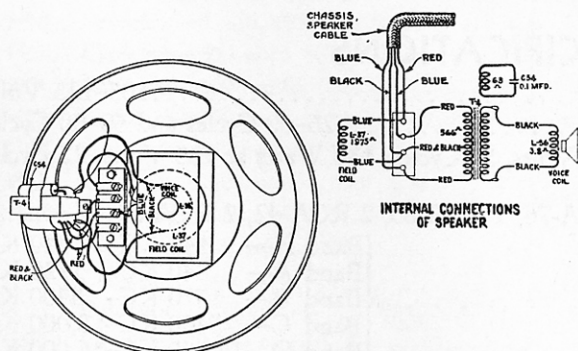

Figure 1—Loudspeaker Wiring—Without Plug

the preceding lower frequency R. F. and detector coils and the two preceding oscillator coils. This is to prevent "dead" spots due to absorption effects caused by the coils, the natural period of which, without the gang-capacitor connected, falls in the next higher frequency band. This gang-switch also has additional contacts for changing the fidelity in the various bands.

The sensitivity control adjusts the residual bias voltage for the R. F. and first detector stages, thereby controlling the overall sensitivity of the receiver.

The output of the first detector, which is the I. F. signal (460 KC), is fed directly through two tuned circuits to the grid of the I. F. amplifier stage. The I. F. stage, which utilizes Radiotron RCA-6D6, uses two transformers, which consist of four tuned circuits, all of which are tuned to 460 KC.

From the output of the I. F. amplifier, the signal is applied to the input of the second detector stage, which consists of an RCA-85 Radiotron, a duplex-diode triode type. This tube performs the functions of a detector, audio amplifier, and automatic volume control. These functions take place in the following sequence. The signal is detected by one of the diodes of the tube; the resulting current develops a voltage across the series combination of resistors, R-32 and R-17. This voltage is composed of a direct current voltage, upon which an audio wave is superimposed. The d. c. portion of the voltage is filtered by the resistor and capacitor system through capacitor C-39 and resistor R-15 and used to automatically regulate the control grid bias of the first R. F. stage. A smaller portion of the d. c. component in the

detected signal is secured from across R-17 alone and used for automatic control of the first detector and I. F. stages. Filtering for this part of the control system is obtained from R-16 and C-35. The audio component of the detected signal across resistor R-17 is introduced to the control grid of the RCA-85 through the wiper arm of R-17 and the capacitance, C-44. Manual volume control action is obtained from this element of the circuit. Resistor R-34 and capacitor C-43 form a tone compensating circuit which improves apparent quality of reproduction at low volume settings.

The signal on the control grid of the RCA-85 controls the plate of the tube and its output circuit. At this point the tone control network is included. Provision is made for regulating both the high and low frequency limits of response. Coupling to the grids of the RCA-76 driver stage is accomplished through a transformer.

In the intermediate audio or driver stage of the receiver, there are two RCA-76 Radiotrons, a triode type, connected to operate push-pull. The bias of the control grids is obtained from a resistor common to the cathode return circuits. This resistor is shown as R-25 on the schematic.

The driver stage is transformer coupled to the output stage, which consists of two Radiotrons, RCA-42, connected in push-pull. A feature of the output stage is the use of fixed bias, which reduces distortion and increases the available output. This is accomplished by the use of the drop across R-29, which carries the entire DC output from the rectifier. Naturally the output stage uses but a portion of the total rectified

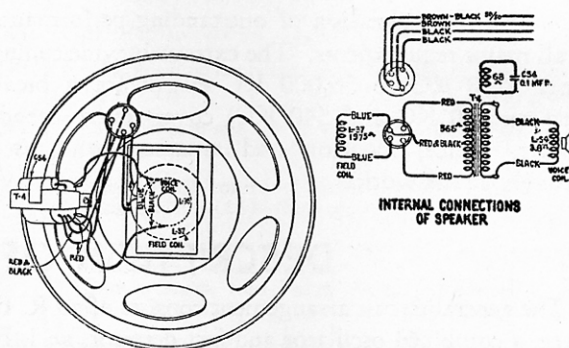

Figure 2—Loudspeaker Wiring for Plug-In Type

current and current variations in it have but little effect on the drop across the resistor.

At this point, it should be noted that an additional group of contacts on the selector switch provides a means whereby the fidelity is changed for the various frequency bands. Two changes, one for Bands X and A and one for Bands B, C and D, are made. The

change is made in order to provide the utmost in tonal quality on Band X and A while reducing the low frequency output on Bands B, C and D. Such low frequency reduction insures the best possible results on these bands.

The output of the power stage is coupled through a step-down transformer to the voice coil of the loudspeaker. A separate winding, which is shunted by a capacitor, has been provided in this transformer which adds to the very sharp, high-frequency cut-off of the entire audio system. This greatly reduces the reproduction of any high-frequency interchannel interference or other disturbance of a high-frequency character which is outside of the useful musical range.

The loudspeaker employed is constructed to be appropriate to the design of the circuit and the acoustic characteristics of the cabinet, in obtaining the over-all high quality of reproduction. It is fully capable of handling the unusual power level obtain-

able from the amplifier, and converting it into clear and faithfully natural sound. The speaker mechanism is of the electro-dynamic type, having a low impedance moving coil, which drives a ten-inch diameter cone. On some models of the 262 and 263, a new method of connection is used on the speaker cable, which is a four-wire cord connector. This scheme of connection makes for ease in removing the chassis from the cabinet for servicing. The plug-in type of speaker wiring is shown in Figure 2, and the type with a terminal strip shown by Figure 1.

In the Schematic Circuit Diagram of Figure 3, the useful electrical constants are specified adjacent to the resistors, capacitors, transformers and coils. Their actual physical locations and the wiring layout of the chassis are given by the diagram of Figure 4. The R. F. and first detector assembly, which is individually removable from the chassis, is shown in the layout of Figure 5.

SERVICE DATA

(1) LINE-UP PROCEDURE

The line-up procedure for these receivers is somewhat involved and it is important that these instructions be carefully followed when making adjustments. Properly aligned, they have outstanding performance, otherwise, poor reception may be experienced.

Equipment

To align this receiver, proper test equipment must be used. This consists of a modulated R. F. oscillator having proper frequency range, an output indicator, an alignment tool and a tuning wand. These parts have been developed by the manufacturer of this receiver for use by service men to duplicate the original factory adjustments.

Checking with Tuning Wand

Before making any R. F., oscillator or first detector adjustments, the accuracy of the present adjustments may be checked by means of the tuning wand (Stock No. 6679). The tuning wand consists of a bakelite rod having a brass cylinder at one end and a special finely divided iron insert at the other end. Inserting the cylinder into the center of a coil lowers its inductance, while inserting the iron end increases its inductance. From this, it is seen that unless the trimmer adjustment for a particular coil is correctly adjusted, inserting one end of the wand may increase the output of a particular signal. A perfect adjustment is evidenced by a lowering of output when either end of the wand is inserted into a coil.

The shields over the R. F. coil assembly have a hole at their top for entrance of the tuning wand. The location of the various coils inside of the shield is shown in Figure 6. An example of the proper manner of using the tuning wand would be to assume the external oscillator were set at 1720 KC and the signal tuned in. The output indicator should be connected across the voice coil of the loudspeaker. Then insert the tuning wand, first one end and then the other end, into the top of the three transformers at the left of the R. F. assembly, facing the front of the chassis. A perfect adjustment of the trimmer would be evidenced by a reduction in output when either end of the wand is inserted in each of the three transformers. If one end—for example, the iron end—when inserted in one coil caused an increase in output, then that circuit is out of alignment. An increase in the trimmer capacitance would be the proper remedy.

(2) I. F. TUNING CAPACITOR ADJUSTMENTS

There is one I. F. stage, with two I. F. transformers in the receiver. A total of four adjustable capacitors are used, two on each transformer. The transformers are both peaked at 460 KC.

A detailed procedure for making this adjustment follows:

- (a) Connect the output of an external oscillator tuned to 460 KC between the first detector grid and ground. Connect the output indicator across the voice coil of the loudspeaker.

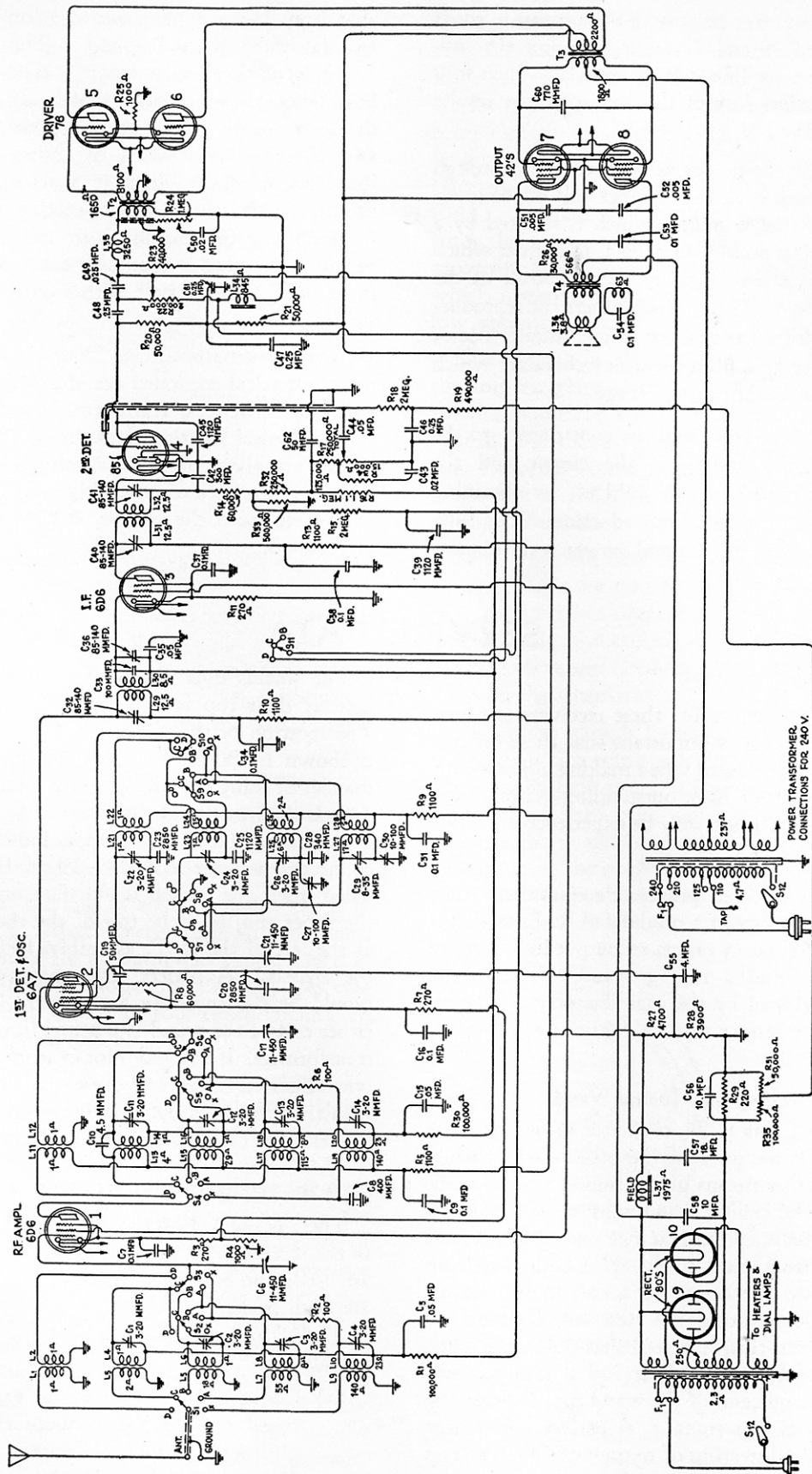

Figure 3—Schematic Circuit Diagram (1935 production 262 and 1935 production 263)

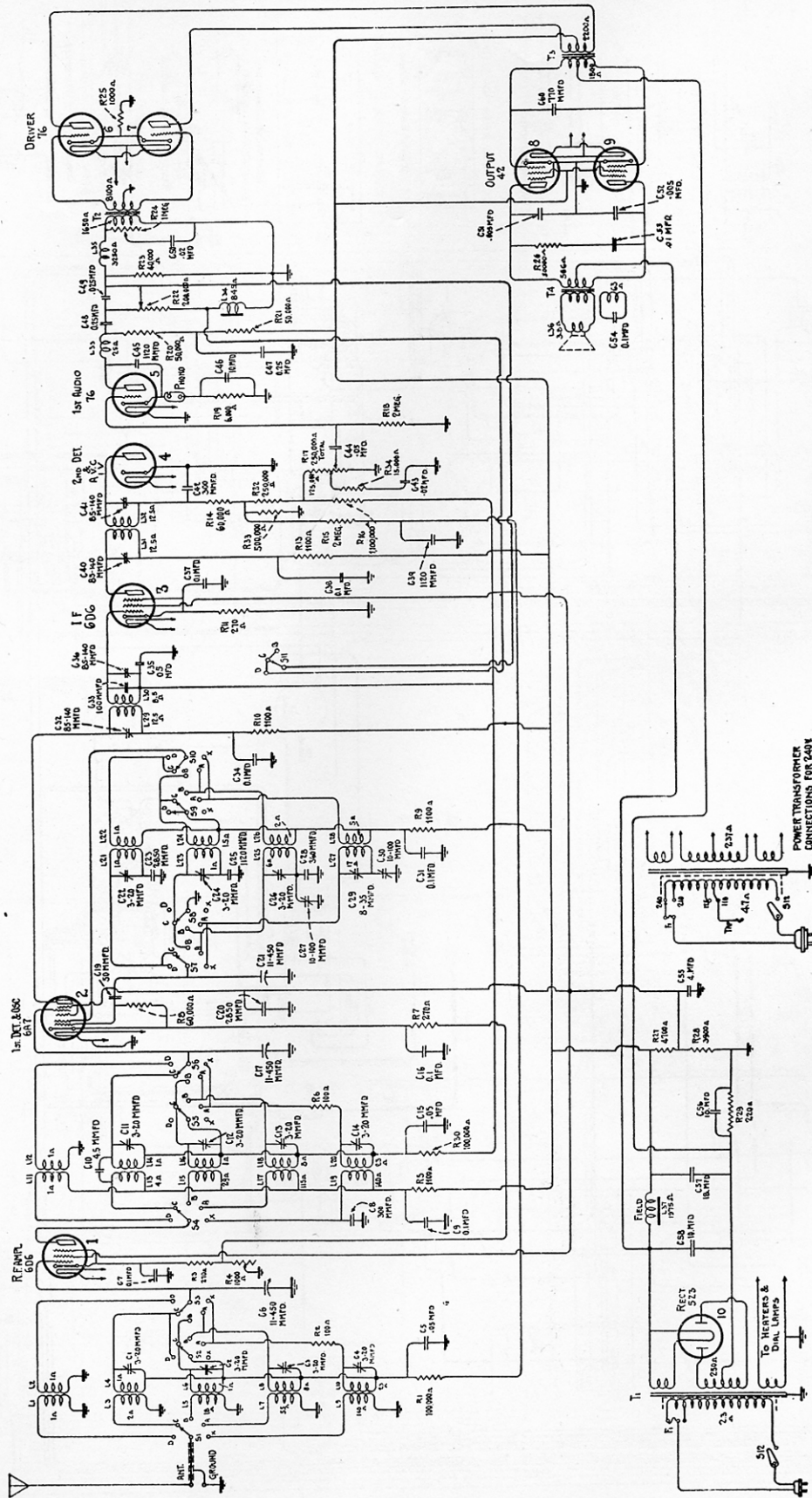

Figure 3.4—Schematic Circuit Diagram (late 1934 production 262 and late 1934 production 263)

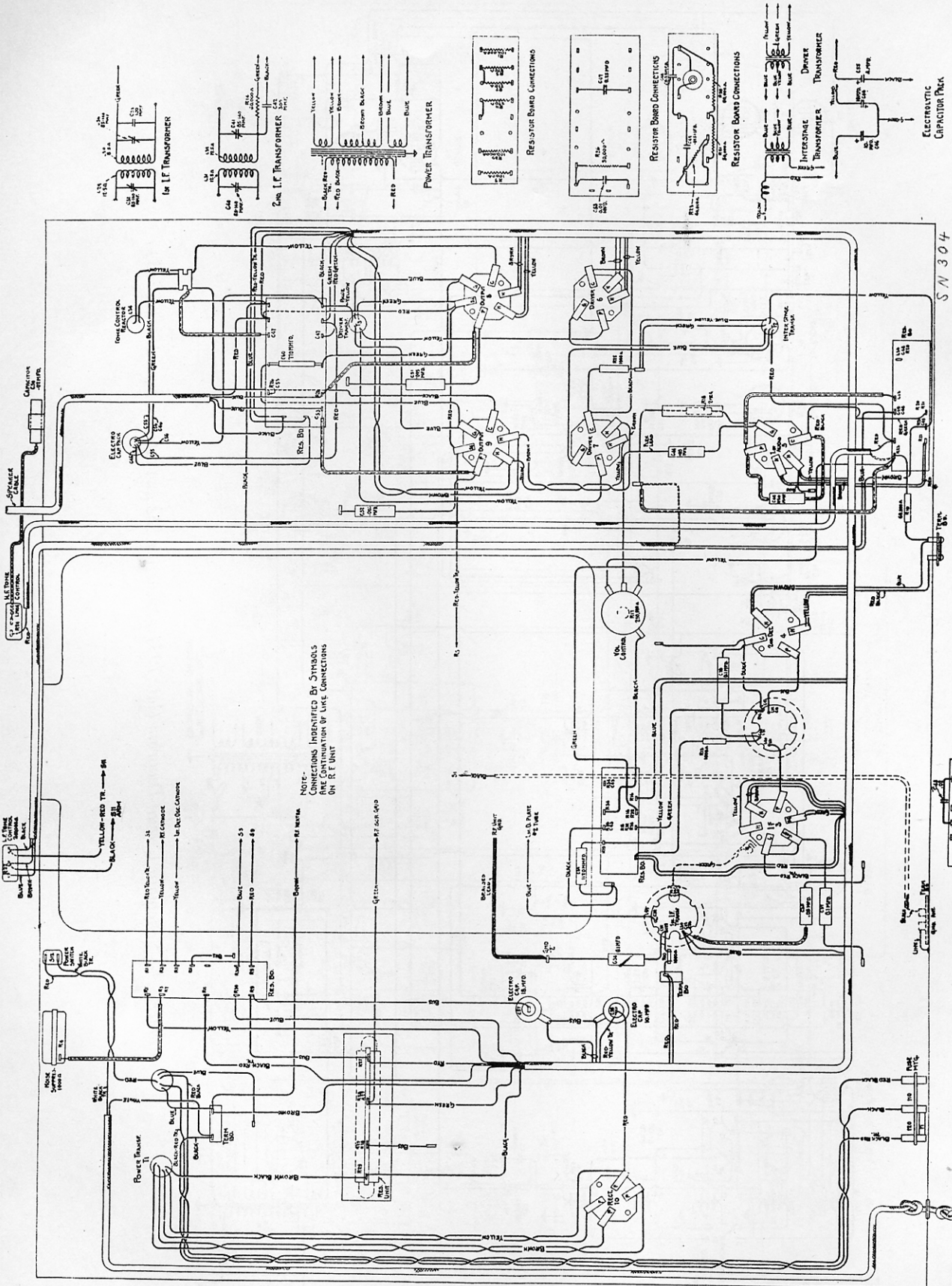

Figure 4.4—Chassis Wiring Diagram (late 1934 production, 262 and late 1934 production 263)

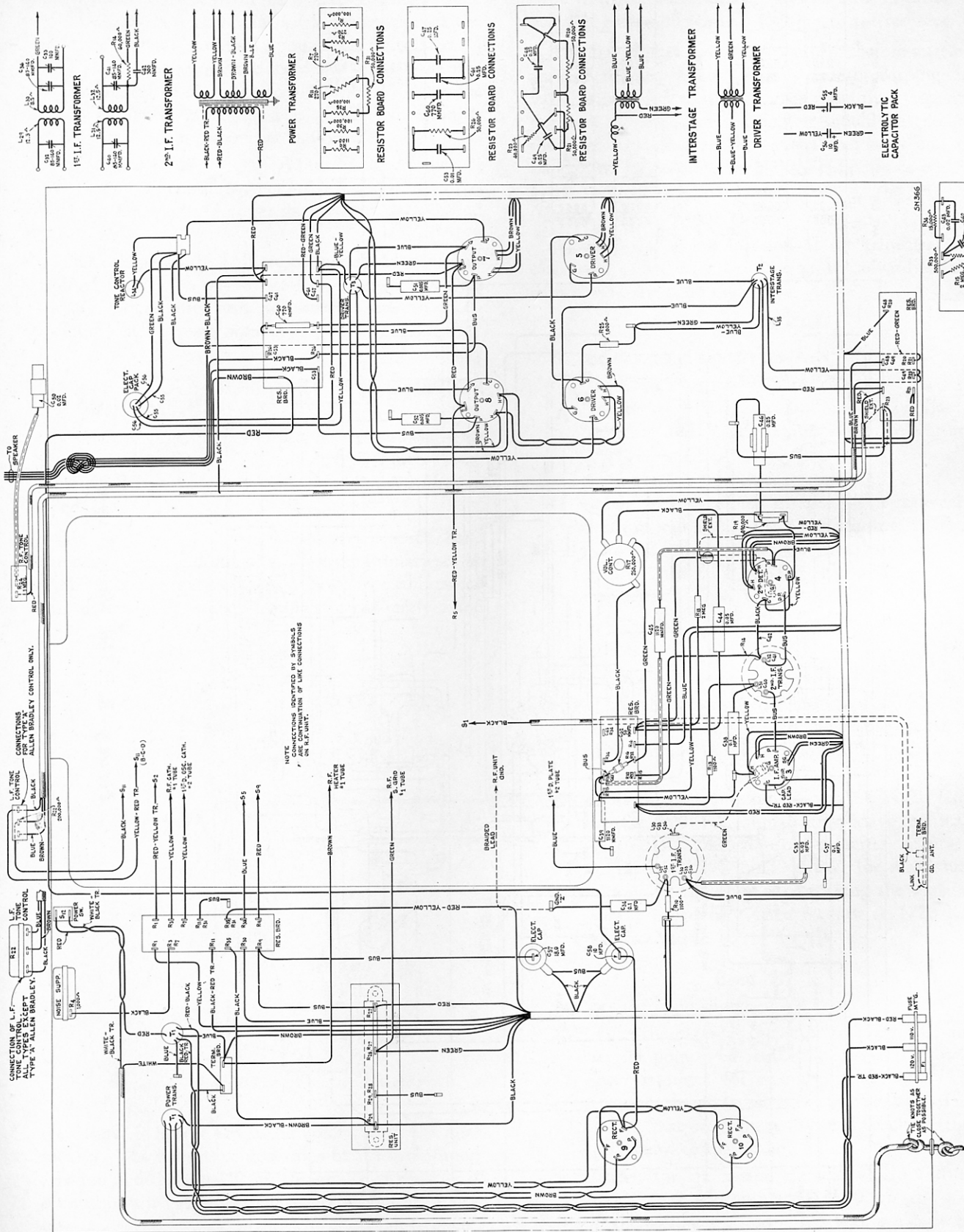

Figure 4—Chassis Wiring Diagram (1935 production 262 and 1935 production 263)

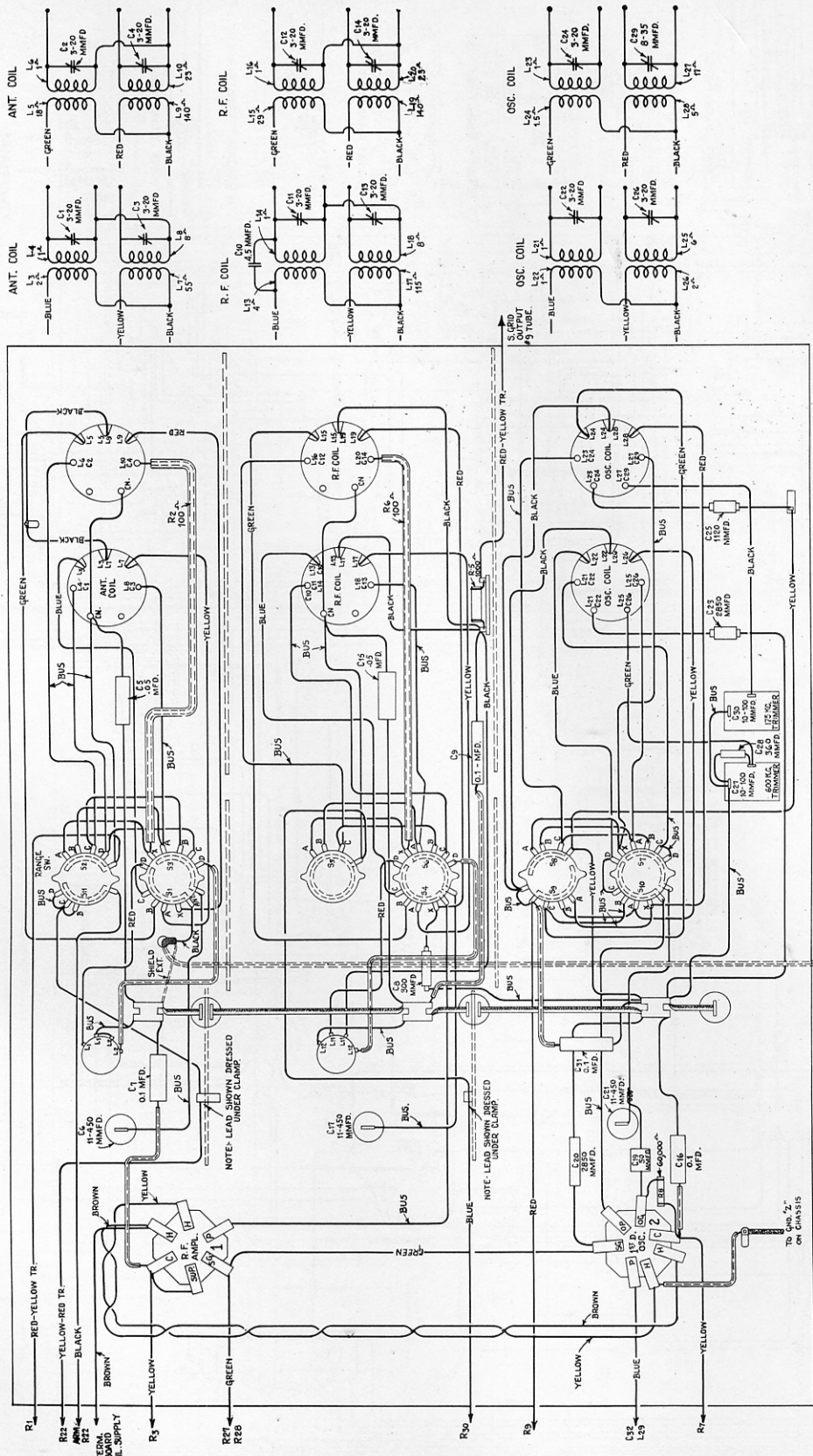

Figure 5—R. F. Unit Wiring Diagram

- (b) Place the oscillator in operation at 460 KC. Place the receiver in operation and adjust the station selector until a point is reached (Band A) where no signals are heard and turn the volume control to its maximum position. Reduce the oscillator input until a slight indication is obtained in the output indicator.
- (c) Refer to Figure 7. Adjust each trimmer of the I. F. transformers until a maximum output is obtained. Go over the adjustments a second time.

This completes the I. F. adjustments. However, it is good practice to follow the I. F. adjustments with the R. F. and oscillator adjustments due to interlocking which always occurs.

(3) R. F. OSCILLATOR AND FIRST DETECTOR ADJUSTMENTS

Four R. F., oscillator and first detector adjustments are required in Bands "A" and "X." Three are required in Bands "B" and "C." None are required in Band "D."

To properly align the various bands, each band must be aligned individually. The preliminary set-up requires the external oscillator to be connected between the antenna and ground terminals of the receiver and

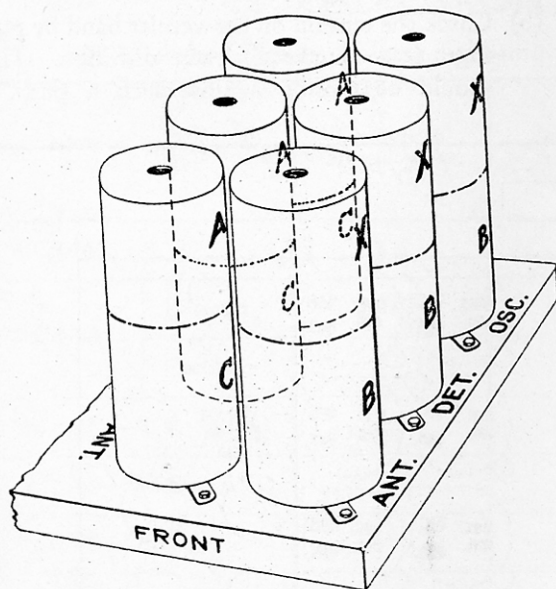

Figure 6—Location of Coils in Shields

the output indicator across the voice coil of the loudspeaker. The volume control must be at its maximum position and the input from the oscillator must be at the minimum value possible to get an output indication under these conditions. In the high-frequency bands, it may be necessary to disconnect the oscil-

lator from the receiver and place it at a distance in order to get a sufficiently low input to the receiver.

The dial pointer must be properly set before starting any actual adjustments. This is done by turning the variable capacitor until it is at its maximum capacity position. One end of the pointer should be toward the horizontal line at the lowest frequency end of Band "A," while the other end should point to within 1/64 inch of the horizontal line at the highest frequency end of band "A."

Figure 7 shows the location of the trimmers for each band. Care must be exercised to only adjust the trimmers in the band under test.

Band "X"

- (a) Set the band switch at "X."
- (b) Tune the external oscillator to 410 KC, set the pointer at 410 KC and adjust the oscillator, detector and R. F. trimmers for maximum output.
- (c) Shift the external oscillator to 175 KC. Tune in the 175 KC signal irrespective of scale calibration and adjust the series trimmer marked 175 KC on Figure 7, for maximum output, at the same time rocking the variable tuning capacitor. Then readjust at 410 KC as described in (a).

Band "A"

- (a) Set the band switch at "A."
- (b) Tune the external oscillator to 1720 KC, set the pointer at 1720 KC and adjust the oscillator, detector and R. F. trimmers for maximum output.
- (c) Shift the external oscillator to 600 KC. Tune in the 600 KC signal irrespective of scale calibration and adjust the series trimmer, marked 600 KC on Figure 7, for maximum output, at the same time rocking the variable tuning capacitor. Then readjust at 1720 KC as described in (a).

Band "B"

- (a) Set the band switch at "B."
- (b) Tune the external oscillator to 5160 KC, and set the pointer at 5160 KC. Adjust the oscillator trimmer for maximum output. The trimmer should be set at the first peak obtained when increasing the trimmer capacitor from minimum to maximum.
- (c) Check for the image signal, which will be received at approximately 4240 on the dial if the oscillator trimmer has been set correctly in accordance with paragraph (b).

It will probably be necessary to increase the external oscillator output for this check.

- (d) Reset the dial to 5160 KC and peak the antenna and detector trimmers for maximum output.

Band "C"

- (a) Set the band switch at "C."
- (b) Tune the external oscillator to 18,000 KC, and set the pointer at 18 M. C. Adjust the oscillator trimmer for maximum output. The trimmer should be set at the first peak obtained when increasing the trimmer capacity from minimum to maximum.
- (c) Check for the image signal, which should be received at approximately 17,080 on the dial. It may be necessary to increase the external oscillator output for this check.
- (d) Reduce the capacity of the detector trimmer, while rocking the tuning capacitor, until the signal disappears. The first detector circuit is then aligned with the oscillator circuit and the RCA-6A7 tube is blocked. Then increase the capacity of the detector trimmer, while rocking the tuning capacitor, until the signal is peaked for maximum output.
- (e) The antenna trimmer should now be peaked for maximum output. It is not necessary to rock the main tuning capacitor while making this adjustment.

Band "D"

No adjustments are required for Band "D."

(4) MAGNETIC PICKUP CONNECTIONS

A convenient point for attachment of a phonograph turntable exists at the RCA-85 second detector stage, where such an input may be connected between the control grid cap and ground. A switching arrangement should be provided for disconnecting or shorting the antenna input to prevent the reception of radio signals when the record adjunct is being used. It will be necessary to provide an external volume control for the phonograph. The wiring should be well shielded to prevent "hum" pickup.

(5) ADJUSTMENT OF DIAL VERNIER MECHANISM

A small vernier indicator is provided for giving a simple means of band spread. Under normal conditions, adjustment of this mechanism will not be required. However, in event the initial adjustment is not satisfactory or adjustment is required because of replacement, the following procedure should be used:

- (a) Remove the chassis from the cabinet to a place convenient for work.
- (b) Check the tension on the vernier hand by pushing it in a counter-clockwise direction. There should be tension against such a push. If

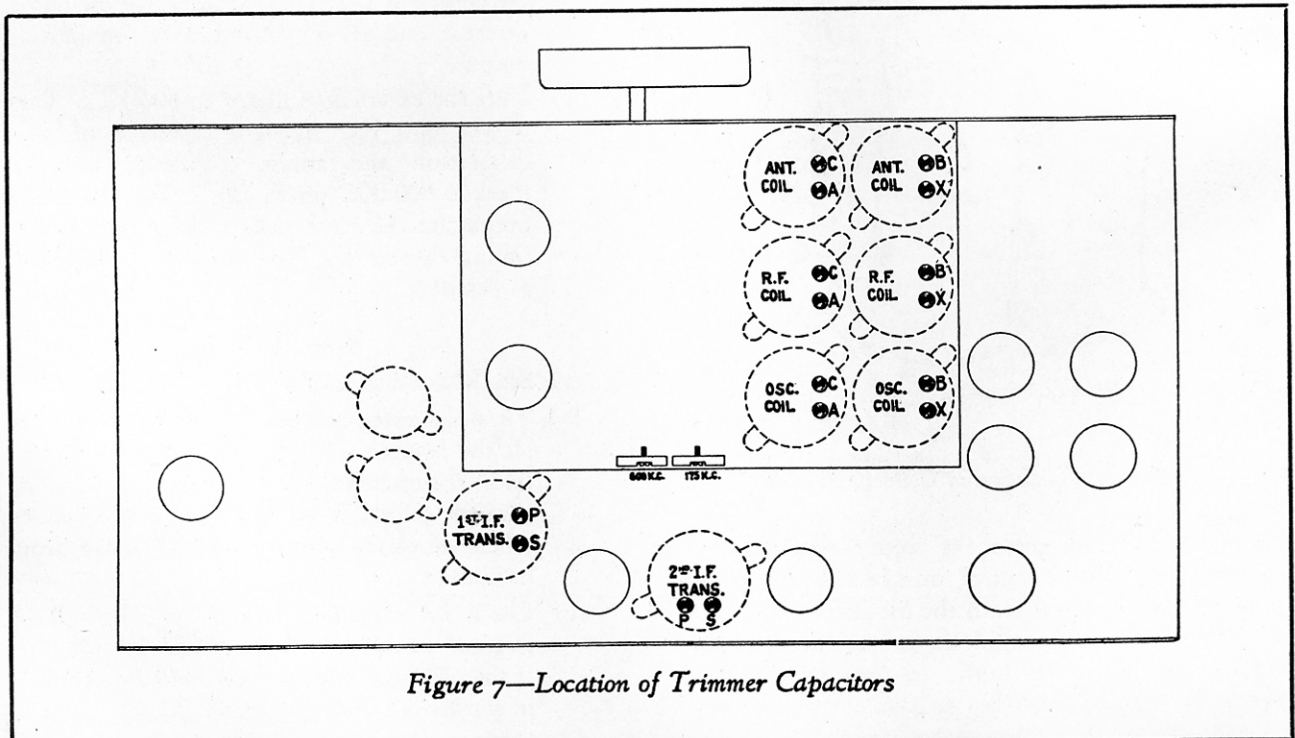

Figure 7—Location of Trimmer Capacitors

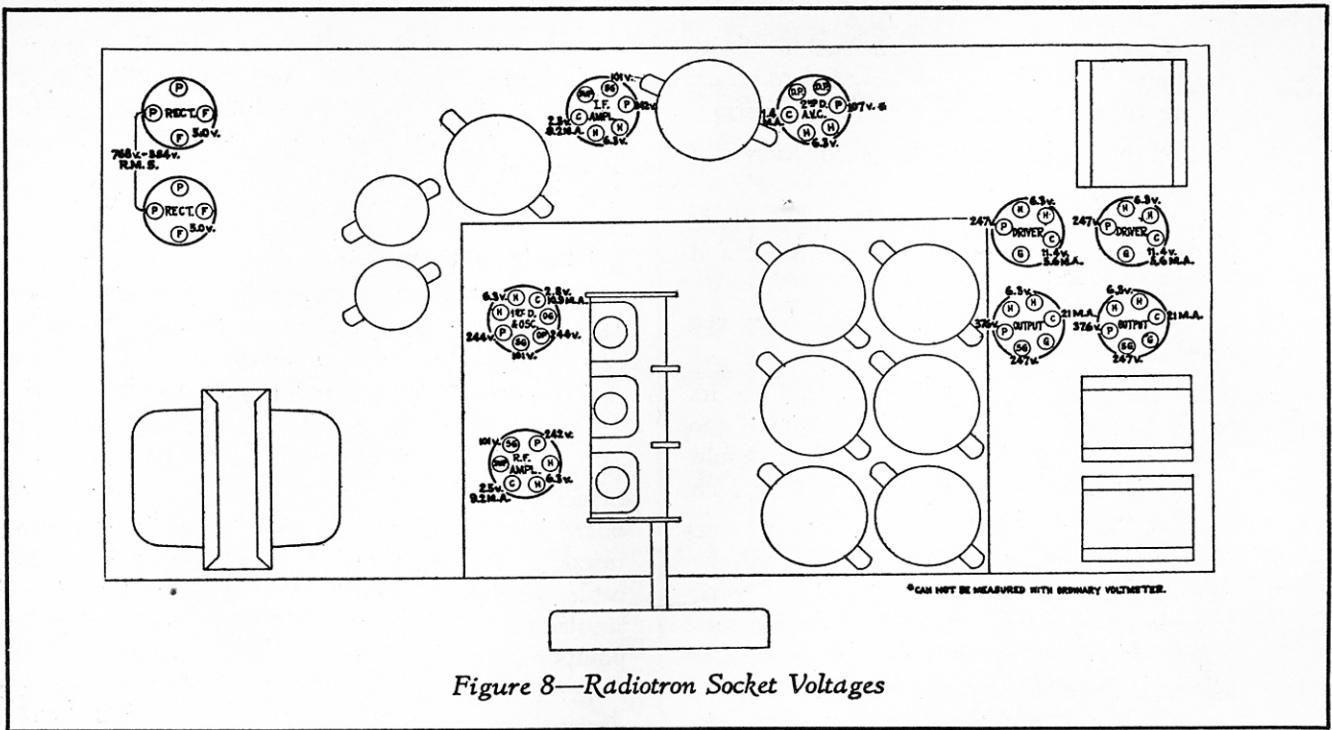

Figure 8—Radiotron Socket Voltages

RADIOTRON SOCKET VOLTAGES

120-Volt A. C. Input—Volume and Sensitivity Controls Maximum—Band Switch at "A"—No Signal

Radiotron Type and Purpose	Cathode to Ground Volts, D. C.	Screen Grid to Ground Volts, D. C.	Plate to Ground Volts, D. C.	Cathode Current, M. A.	Heater Volts, A. C.
RCA-6D6—R. F.	2.5	101	242	9.2	6.3
RCA-6A7	Detector	101	244	10.9	6.3
	Oscillator	—	244		
RCA-6D6—I. F.	2.5	101	242	9.2	6.3
RCA-85—2nd Det. AVC	0	—	107*	1.4	6.3
RCA-76—Driver	11.4	—	247	5.6	6.3
RCA-76—Driver	11.4	—	247	5.6	6.3
RCA-42—Power	0	247	376	21.0	6.3
RCA-42—Power	0	247	376	21.0	6.3
RCA-80—Rectifier	—	—	768/384 R. M. S.	56.0	5.0
RCA-80—Rectifier	—	—		56.0	5.0

*Cannot be measured with ordinary voltmeter.

this tension does not exist, the action of the hand may be erratic and possibly fail to return to the same position for a particular station.

- (c) Pull off the long hand with a pair of long-nose pliers.
- (d) Straighten the lugs that hold the dial in place. Then remove the dial "vernier" hand and stem gear together.
- (e) Then remove the "vernier" hand from the stem gear.
- (f) Turn the dial to each extreme and to its center position and check the backlash of the back gear (closest to reflector). There should be definite backlash in each direction at each of these three positions.
- (g) If this backlash is not obtained, it will be necessary to re-adjust the position of the gears. Loosen the lock-screw located above the central set of gears and move the adjoining gear assembly in or out of mesh as required.
- (h) After making sure there is backlash at the three check points mentioned, turn the outside gear in a clockwise direction $1\frac{1}{2}$ turns. Hold it at this position and replace the stem gear.
- (i) Turn the dial throughout its range. If the gears become noisy, move the gear further toward the reflector edges described in (g).
- (j) Replace the dial scale, making sure the hole clears the spindle.
- (k) Replace the vernier hand. It should point at zero when the tuning capacitor is fully meshed.
- (l) Replace the large hand. One end of the pointer should point exactly at the horizontal line at the lowest frequency end of Band "A" when the tuning capacitor is fully meshed.

The above covers the proper manner of making adjustments, assuming all parts are in normal condition. Of course, if any part is defective, it must be replaced. The spring gear may be checked by turning it until the spring is tight and unwinding it slowly. It should unwind $4\frac{1}{4}$ turns.

(6) HUM INDUCTION

In chassis of early manufacture (models with a type-76 or 1-v second detector), a slight "buzz" or "hum" will often be encountered. In order to reduce this interference the following steps should be taken:

(1) Remove the connections of the *red with yellow tracer* lead from the 10 mfd. electrolytic capacitor (C-56) and from the lug on the resistor board where it terminates. In place of this conductor, install a new one that will be outside of the chassis cable, carried along the front side of the chassis, similar to the *red* lead connecting the corresponding points on the wiring diagram of Figure 4.

(2) Connect the grounding lead from the second detector cathode to a ground point nearer the detector socket.

(3) The secondary leads of the interstage transformer connecting to the driver stage, should be kept away from the heater prongs and heater wiring. It is desirable to shorten these leads as much as possible.

(4) It is important that the heater leads of the audio stages of the receiver be carefully twisted.

(7) VOLTAGE READINGS

The voltages given on the preceding page are those at the various tube sockets while the receiver is in operating condition. No allowance has been made for currents drawn by the meter, and if low-resistance meters are used, such allowances must be made. Figure 8 shows a diagram in which the various voltages at the tube contacts are shown.

REPLACEMENT PARTS

Insist on genuine factory tested parts, which are readily identified and may be purchased from authorized dealers

Stock No.	DESCRIPTION	List Price	Stock No.	DESCRIPTION	List Price
RECEIVER ASSEMBLIES					
4372	Bracket—Bass tone control mounting bracket.	\$0.20	3744	Resistor—250,000 ohms—Carbon type— $\frac{1}{4}$ watt (R32)—Package of 5.....	\$1.00
4683	Bracket—Treble tone control mounting bracket.....	.25	6186	Resistor—500,000 ohms—Carbon type— $\frac{1}{4}$ watt (R33)—Package of 5.....	1.00
4406	Bracket—Volume control mounting bracket..	.25	4783	Resistor—1,100,000 ohms—Carbon type— $\frac{1}{4}$ watt (R16)—Package of 5.....	1.00
4416	Capacitor—50 mmfd. (C62)—Package of 5..	1.25	6242	Resistor—2 megohms—Carbon type— $\frac{1}{4}$ watt (R15, R18)—Package of 5.....	1.00
3794	Capacitor—100 mmfd.—Located on first I.F. transformer (C33).....	.30	3594	Resistor—50,000 ohms—Carbon type— $\frac{1}{2}$ watt (R20, R21)—Package of 5.....	1.00
3981	Capacitor—300 mmfd.—Located on second I. F. transformer (C42).....	.30	2240	Resistor—30,000 ohms—Carbon type—1 watt (R26).....	.22
4668	Capacitor—770 mmfd. (C60).....	.30	4649	Resistor—Flat type—Total resistance 8820 ohms—Divided as follows: one 220 ohms, one 3,900 ohms and one 4,700 ohms section (R27, R28, R29).....	1.05
4409	Capacitor—1120 mmfd. (C39, C45).....	.35	7804	Rheostat—Sensitivity control rheostat (R4)..	1.30
4838	Capacitor—0.005 mfd. (C51, C52).....	.20	4656	Screw—Volume control mounting assembly—Comprising one bushing, one washer, one shakeproof washer and one nut.....	.18
3787	Capacitor—0.01 mfd. (C53).....	.30	4452	Shield—Second detector A.V.C. Radiotron shield.....	.35
3639	Capacitor—0.02 mfd. (C43).....	.25	3683	Shield—Second detector—A.V.C. Radiotron shield top.....	.20
4652	Capacitor—0.02 mfd. (C50).....	.60	4453	Shield—I. F. Radiotron shield.....	.32
4836	Capacitor—0.05 mfd. (C35).....	.30	4742	Shield—Intermediate frequency transformer shield.....	.40
4694	Capacitor—0.05 mfd. (C44).....	.30	4784	Socket—4-contact rectifier Radiotron socket..	.15
3765	Capacitor—0.025 mfd. (C49).....	.34	4814	Socket—5-contact driver Radiotron socket...	.15
4835	Capacitor—0.1 mfd. (C38).....	.28	4786	Socket—6-contact I. F. amplifier—Second detector—"A.V.C." or output Radiotron socket.....	.15
4841	Capacitor—0.1 mfd. (C34, C37).....	.22	4686	Strip—"ANT-GND" terminal strip—Two terminals and link.....	.20
3597	Capacitor—0.25 mfd. (C46, C47, C61).....	.40	7796	Switch—Operating switch (S12).....	.62
3702	Capacitor—0.25 mfd. (C48).....	.42	4829	Tone control—Bass tone control (R22).....	1.00
7790	Capacitor—10. mfd. (C58).....	1.05	4830	Tone control—Treble tone control (R24)...	1.00
7788	Capacitor—18 mfd. (C57).....	1.10	7841	Transformer—Audio transformer pack comprising interstage transformer and reactor (T2, L35).....	4.05
4831	Capacitor pack—Comprising one 10. mfd. and one 4. mfd. capacitor (C55, C56).....	2.40	4431	Transformer—First intermediate frequency transformer (L29, L30, C32, C33, C36)....	2.28
4420	Clamp—Antenna lead clamp and screw—Package of 10.....	.40	4433	Transformer—Second intermediate frequency transformer (L31, L32, C40, C41, C42)...	2.15
4358	Clamp—Mounting clamp for capacitor—Stock No. 7788 or No. 7790.....	.15	7832	Transformer—Driver transformer (T3).....	2.85
7806	Coil—First audio plate choke (L33).....	.30	9505	Transformer—Power transformer—105-125 volts—50-60 cycles (T1).....	6.35
4371	Cover—Fuse mount cover.....	.15	9506	Transformer—Power transformer—105-125 volts—25-40 cycles.....	8.90
10907	Fuse—3 amperes—Package of 5.....	.40	9507	Transformer—Power transformer—105-250 volts—40-60 cycles.....	6.40
3376	Mount—Fuse mount—105-125 volt operation.....	.40	4832	Volume control (R17).....	1.25
4604	Mount—Fuse mount for 200-250 volt operation.....	.35	R. F. UNIT ASSEMBLIES		
7784	Reactor—Tone control reactor (L34).....	1.30	4244	Cap—Contact cap—Package of 5.....	.20
6135	Resistor—270 ohms—Carbon type— $\frac{1}{4}$ watt (R3, R7, R11)—Package of 5.....	1.00	4646	Capacitor—4.5 mmfd. (C10).....	.20
4687	Resistor—1000 ohms—Carbon type— $\frac{1}{2}$ watt (R25)—Package of 10.....	2.00	4633	Capacitor—50 mmfd. (C19).....	.25
4834	Resistor—1100 ohms—Carbon type— $\frac{1}{4}$ watt (R9, R10, R13)—Package of 5.....	1.00	4842	Capacitor—400 mmfd. (C8).....	.24
4833	Resistor—490,000 ohms—Carbon type— $\frac{1}{4}$ watt (R19)—Package of 5.....	1.00	4811	Capacitor—340 mmfd. (C28).....	.25
3998	Resistor—15,000 ohms—Carbon type— $\frac{1}{4}$ watt (R34)—Package of 5.....	1.00			
6143	Resistor—40,000 ohms—Carbon type— $\frac{1}{4}$ watt (R23)—Package of 5.....	1.00			
3114	Resistor—50,000 ohms—Carbon type— $\frac{1}{4}$ watt (R31)—Package of 5.....	1.00			
3602	Resistor—60,000 ohms—Carbon type— $\frac{1}{4}$ watt (R14)—Package of 5.....	1.00			
3118	Resistor—100,000 ohms—Carbon type— $\frac{1}{4}$ watt (R1, R30, R35)—Package of 5.....	1.00			

REPLACEMENT PARTS (Continued)

Insist on genuine factory tested parts, which are readily identified and may be purchased from authorized dealers

Stock No.	DESCRIPTION	List Price	Stock No.	DESCRIPTION	List Price
4412	Capacitor—1,120 mmfd. (C25).....	\$0.25	7799	Drive—Variable tuning condenser drive assembly complete.....	\$2.45
4524	Capacitor—2,850 mmfd. (C23).....	.35	4827	Gear—Spring gear assembly complete with hub, pinion, gear cover and spring.....	1.25
4615	Capacitor—2,850 mmfd. (C20).....	.34	4704	Indicator—Band indicator—Celluloid lettered—D. C. B. A. X.....	.12
4836	Capacitor—0.05 mfd. (C5, C15).....	.30	4360	Pinion—Vernier pointer pinion.....	.35
4841	Capacitor—0.1 mfd. (C7, C16).....	.22	4363	Pointer—Station selector main (large) pointer.....	.18
4835	Capacitor—0.1 mfd. (C9, C31).....	.28	4367	Pointer—Station selector vernier (small) pointer.....	.15
3861	Capacitor—Adjustable capacitor (C27, C30).....	.78	3943	Screen—Celluloid screen for dial light—Package of 2.....	.18
4420	Clamp—Antenna lead clamp and screw—Package of 10.....	.40	3993	Screw—No. 6-32-5/32" square head set screw for band indicator operating arm or variable condenser drive—Package of 10...	.25
4410	Coil—Antenna coil—Band "D" (L1, L2)....	.70	4377	Spring—Band indicator and arm tension spring—Package of 5.....	.25
7803	Coil—Antenna coil—Band B-C (L3, L4, L7, L8, C1, C3).....	1.82	4378	Stud—Band indicator operating arm stud—Package of 5.....	.25
7810	Coil—Antenna coil—Band X-B (L5, L6, L9, L10, C2, C4).....	2.10			
7805	Coil—Detector coil—Band A-C (L13, L14, L17, L18, C11, C13).....	2.15		CABLE ASSEMBLIES	
7808	Coil—Detector coil—Band X-B (L15, L16, L19, L20, C12, C14).....	2.05	5084	Cable—Main cable.....	1.35
4421	Coil—Detector coil—Band D (L11, L12)....	.70	5083	Cable—4-conductor—Reproducer cable.....	.60
7807	Coil—Oscillator coil—Band A-C (L21, L22, L25, L26, C22, C26).....	1.62	4655	Cable—Shielded cable—From low-frequency tone control to resistor boards.....	.58
7809	Coil—Oscillator coil—Band X-B (L23, L24, L27, L28, C24, C29).....	1.70	5039	Plug—4-contact male plug for reproducer cable.....	.25
4806	Condenser—3-gang variable tuning condenser (C6, C17, C21).....	5.64	5040	Plug—4-contact female plug for reproducer cable.....	.25
4340	Lamp—Dial lamp—Package of 5.....	.60			
4834	Resistor—1100 ohms—Carbon type—1/4 watt (R5)—Package of 5.....	1.00		REPRODUCER ASSEMBLY	
3602	Resistor—60,000 ohms—Carbon type—1/4 watt (R8)—Package of 5.....	1.00	4645	Capacitor—0.1 mfd.—Located on output transformers (C54).....	.25
4418	Resistor—100 ohms—Flexible type (R2, R6)—Package of 10.....	1.50	9583	Coil—Field coil, magnet and cone support (L37).....	5.20
4656	Screw—Chassis mounting screw assembly—Comprising one bushing, one washer, one shakeproof washer, and one nut (four sets required to mount chassis).....	.18	8969	Cone—Reproducer cone (L36)—Package of 5.....	6.35
4742	Shield—Antenna, detector or oscillator coil shield.....	.40	9582	Reproducer—Reproducer complete.....	9.00
3682	Shield—First detector-oscillator Radiotron shield.....	.22	6999	Screen—Dust (cloth) screen—Package of 6...	.12
3683	Shield—Radiotron shield top.....	.20	5080	Transformer—Output transformer and capacitor (T4, C54).....	1.60
4235	Shield—R. F. amplifier Radiotron shield....	.24			
3529	Socket—Dial lamp socket.....	.32		MISCELLANEOUS PARTS	
4786	Socket—6-contact R. F. amplifier Radiotron socket.....	.15	4677	Bezel—Metal bezel (escutcheon) for station selector dial glass.....	.56
4787	Socket—7-contact first detector-oscillator Radiotron socket.....	.15	6614	Glass—Station dial glass.....	.30
7836	Switch—Range switch (S1, S2, S3, S4, S5, S6, S7, S8, S9, S10, S11).....	3.05	3829	Knob—Bass or treble tone control, volume or sensitivity control range switch or operating switch knob—Package of 5.....	1.10
	DRIVE ASSEMBLIES		4657	Knob—Knob station selector knob—Package of 5.....	.65
4362	Arm—Band indicator operating arm.....	.28	4678	Ring—Retaining ring for dial glass—Package of 5.....	.34
10194	Ball—Steel ball for variable condenser drive assembly—Package of 20.....	.25	4119	Screw—8-32-1/4" headless set screw for knob—Stock No. 4657—Package of 20.....	.38
4422	Clutch—Tuning condenser drive clutch assembly—Comprising drive shafts, balls, ring, spring and washers—Assembled.....	.88	4393	Screw—8-32-5/16" headless set screw for knob—Stock No. 3829—Package of 10...	.25
4455	Dial—Station selector dial.....	.60			